

ISO 6432 Miniature Air Cylinders - Mountings

Basic Dimensions

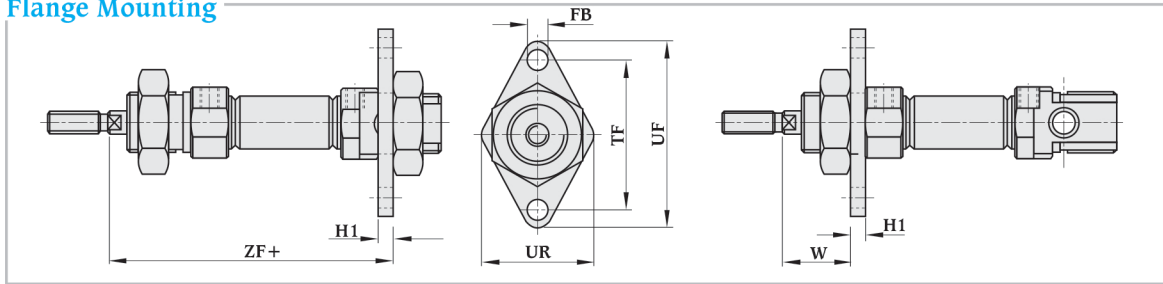

Flange Mounting



Swivel / Trunnion Mounting

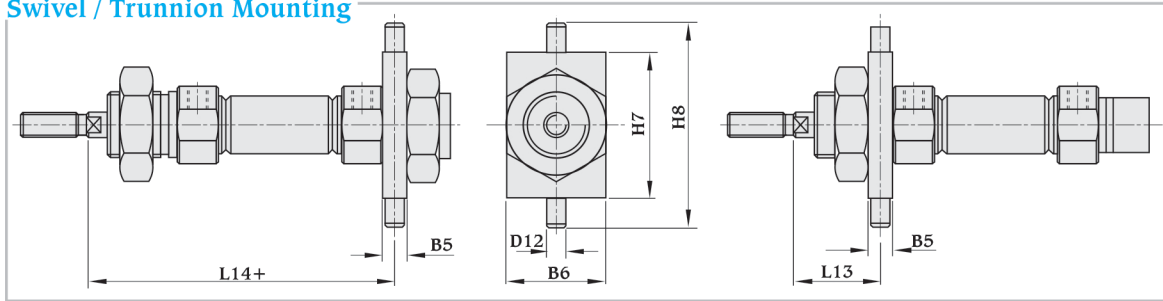

Double Foot Mounting

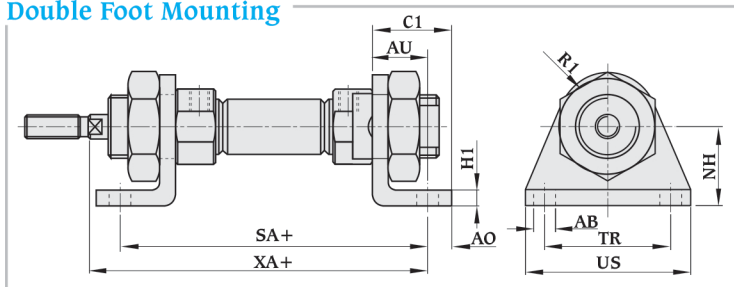

Clevis Foot Mounting

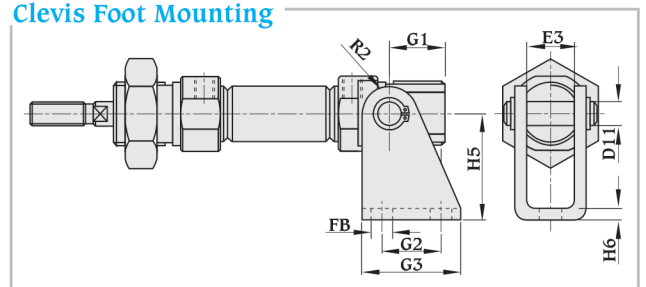

Single Foot Mounting

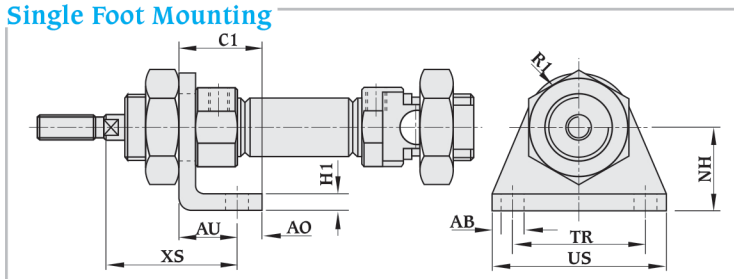

Piston Rod Clevis

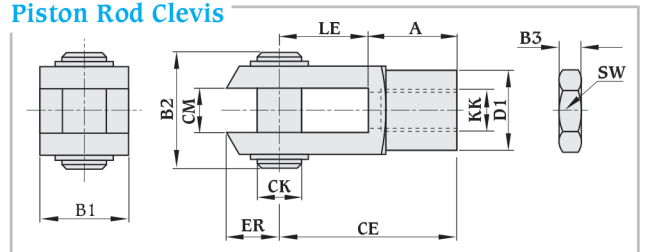

All dimensions in mm unless otherwise specified

Piston dia. mm	A	AB Ø	AO	AU	B1 SQ	B2	B3	B5	B6	C1	CE	CK Ø	CM	D1 Ø	D11 Ø	D12 Ø	E3	ER	FB Ø	G1	G2	G3	H1
Ø 12	12	5.5	6	14	12	16.0	3.2	8	25	20	24	6	6	10	6	6	12.1	7	5.5	13	15	25	4
Ø 16	12	5.5	6	14	12	16.0	3.2	8	25	20	24	6	6	10	6	6	12.1	7	5.5	13	15	25	4
Ø 20	16	6.5	8	17	16	21.5	4.0	8	30	25	32	8	8	14	8	6	16.1	10	6.5	16	20	32	5
Ø 25	20	6.5	8	17	20	26.0	5.0	8	30	25	40	10	10	18	8	6	16.1	12	6.5	16	20	32	5
Piston dia. mm	H5	H6	H7	H8	KK	L13	L14	LE	NH	R1	R2	SA	SW	TF	TR	UF	UR	US	W	XA	XS	ZF	
Ø 12	27	3	38	58	M6 x 1P	18	76.0	12	20	13	7	78.0	10	40	32	50	30	42	18	86.0	32	76.0	
Ø 16	27	3	38	58	M6 x 1P	18	82.0	12	20	13	7	84.0	10	40	32	50	30	42	18	92.0	32	82.0	
Ø 20	30	4	46	66	M8 x 1.25	20	96.5	16	25	20	10	102.5	13	50	40	66	40	54	19	109.5	37	97.5	
Ø 25	30	4	46	66	M10 x 1.25	24	101.5	20	25	20	10	103.5	17	50	40	66	40	54	23	114.5	41	102.5	

Note : Subject to change without prior notice

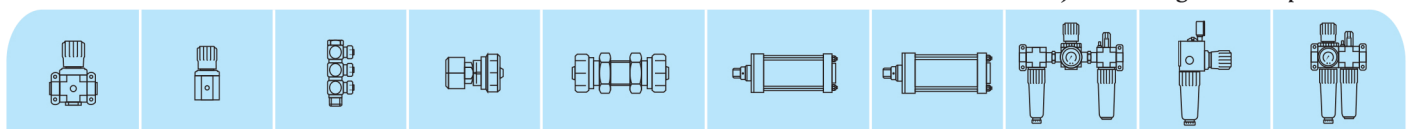

Simplifying technology, redefining value.

www.duttacontrol.com