

HONDA PETROL TANK

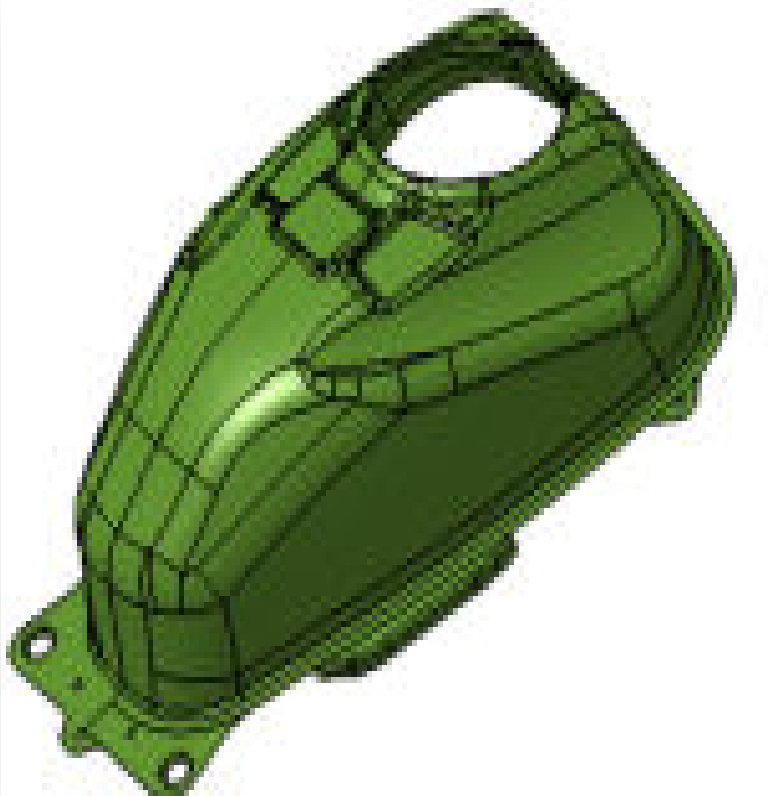

HONDA -MSI_KOEA_FUEL_TANK_LOWER

RED = -0.08
GREEN = 0.0
YELLOW = 0.00
CYAN = DRY RUN

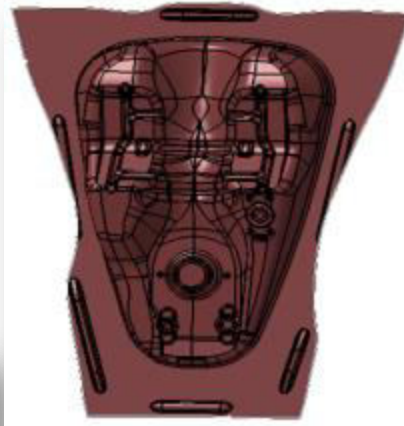

RED = -0.8
GREEN = 0.00
YELLOW = 0.00
BLUE = 0.00
CYAN = DRY RUN

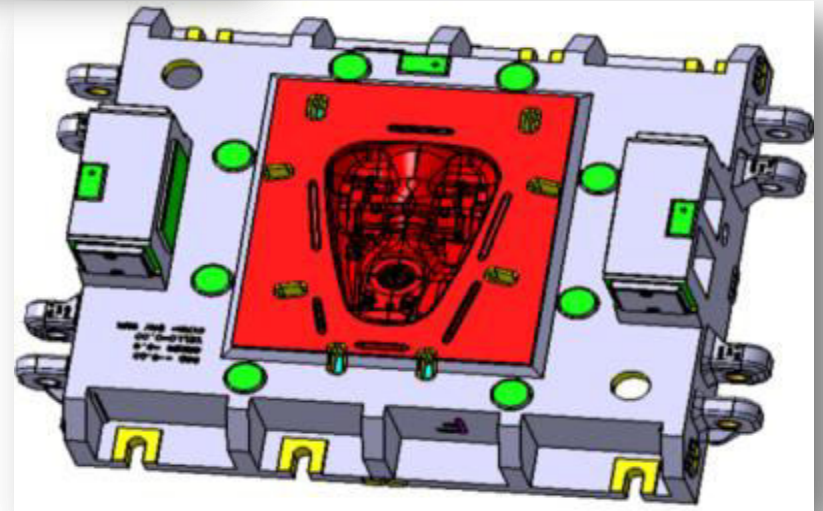
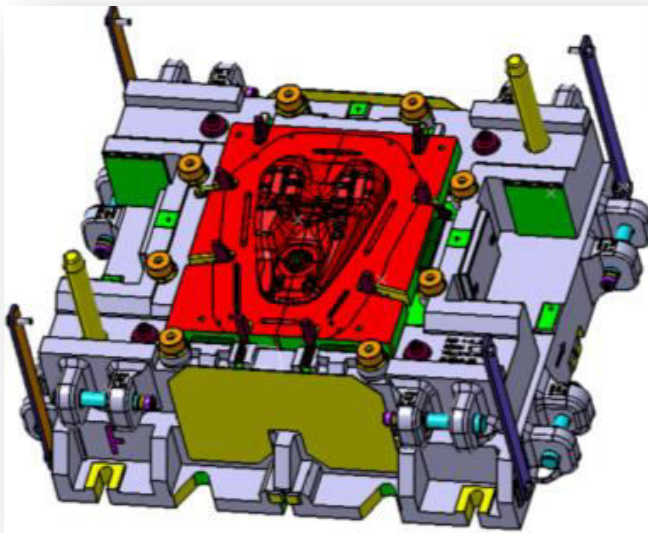

Blank size	Trapezoidal X 0.8 Thick
Blank surface area	204400 mm ²
Part surface area (With Holes)	165420 mm ²
Yield % (With Holes)	81 %
Binder Force	30 T (Cushion)
Draw Force	108 T

Material Name:- CH1751Z-E-0/20

PETROL TANK – OUTER –RCP-

GREEN=0.00
YELLOW=0.0
RED=0.88
MAGENTA =0.04

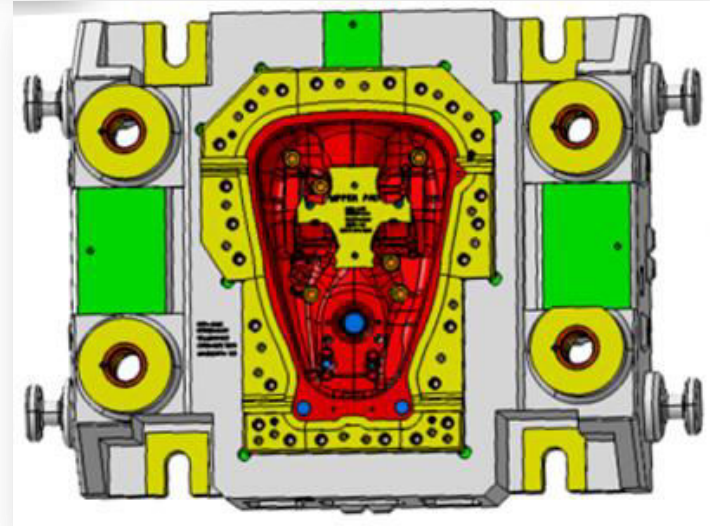
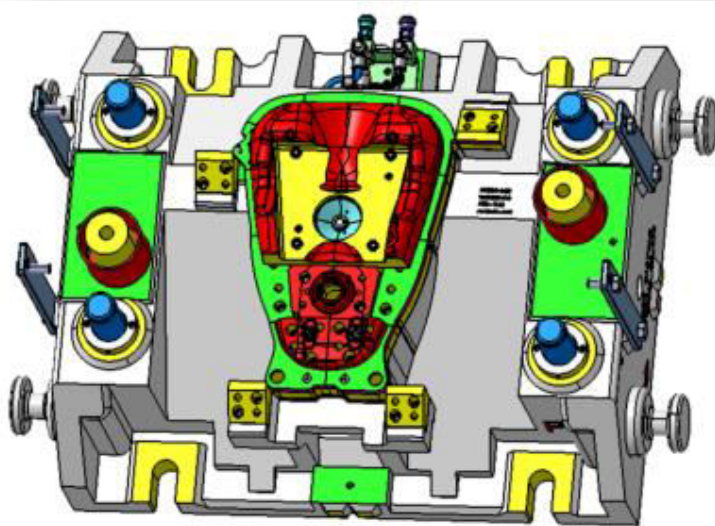
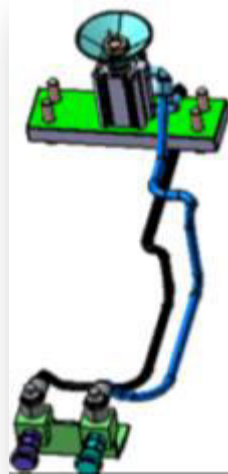

PETROL TANK – OUTER –RCP-

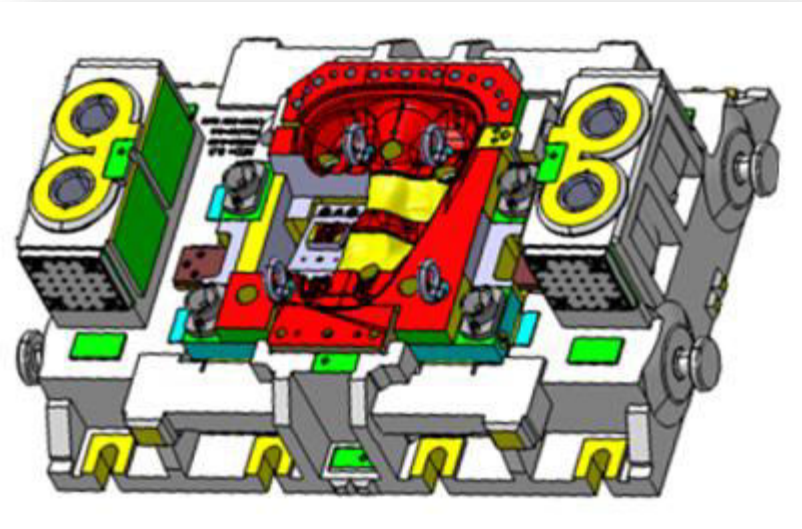
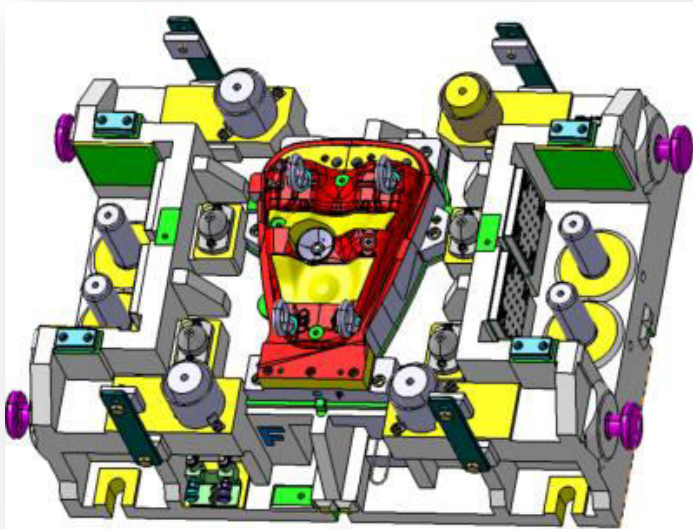
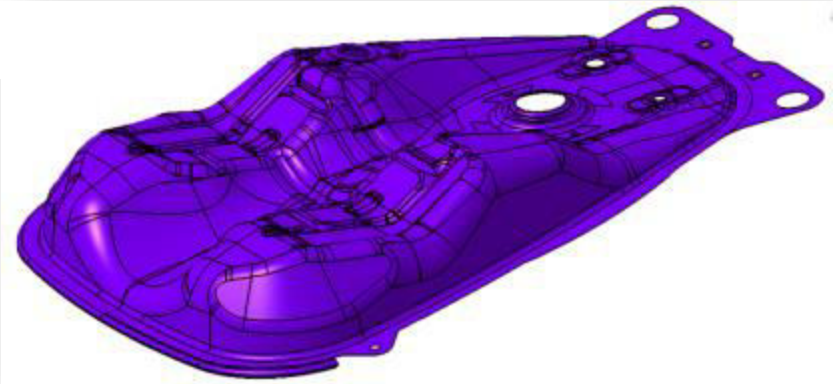
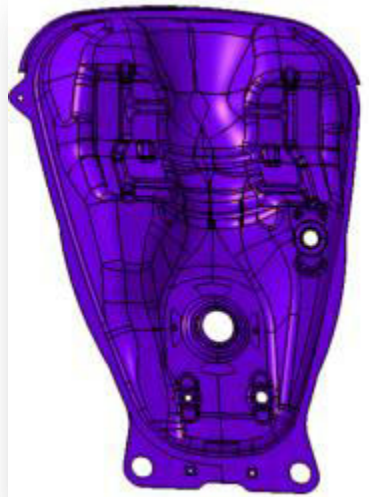

PETROL TANK – OUTER –RCP-

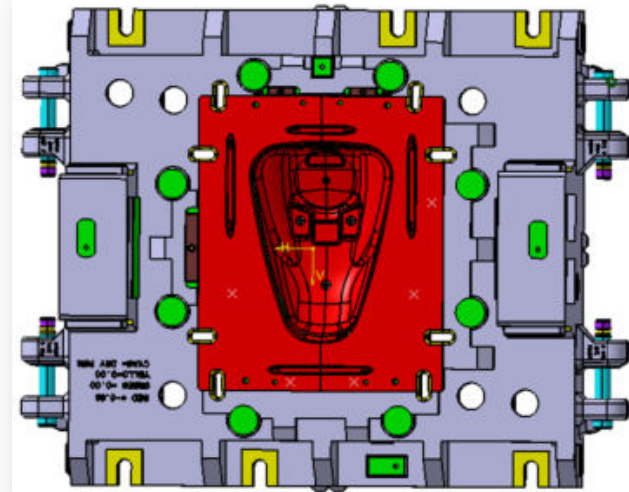
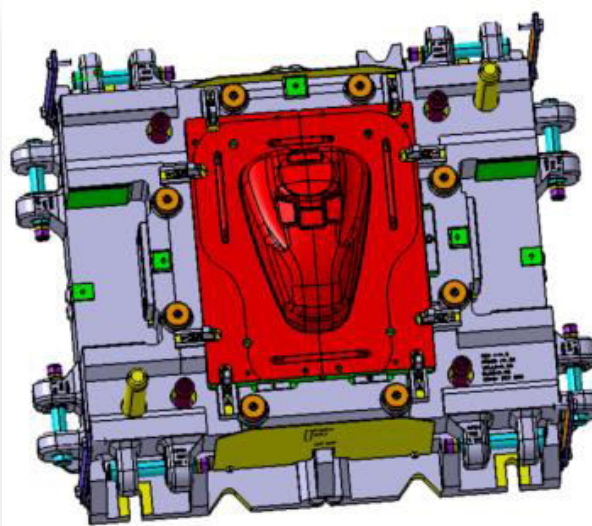
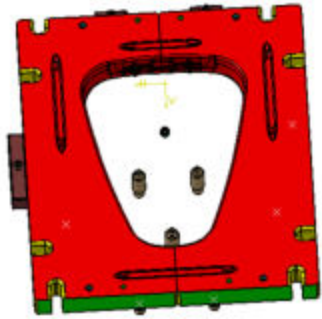

PETROL TANK – OUTER –RCP-

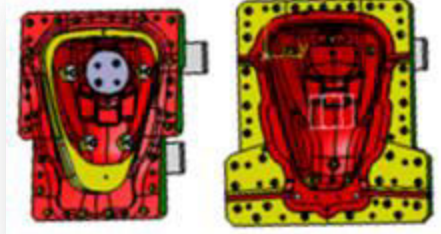
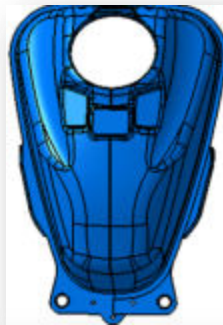

GREEN = 0.00mm
RED = -0.08 mm
YELLOW = 0.00mm
CYAN = DRY RUN
MAGENTA = 0.0

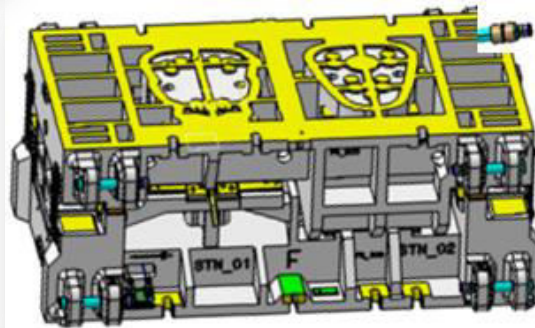

MAGENTA = -0.04
GREEN = 0.00mm
RED = -0.80mm
YELLOW = 0.00mm
CYAN = DRY RUN

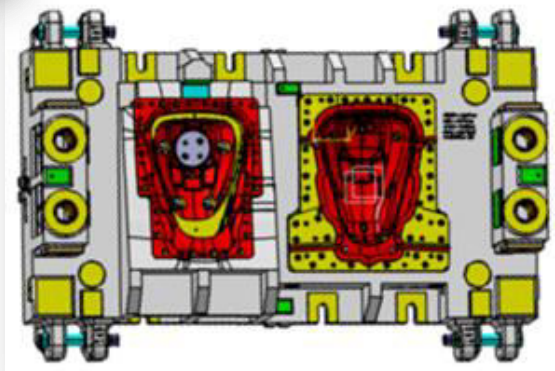
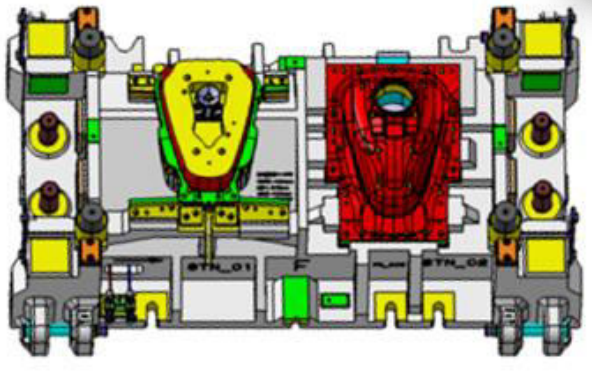

PETROL TANK – OUTER –RCP-

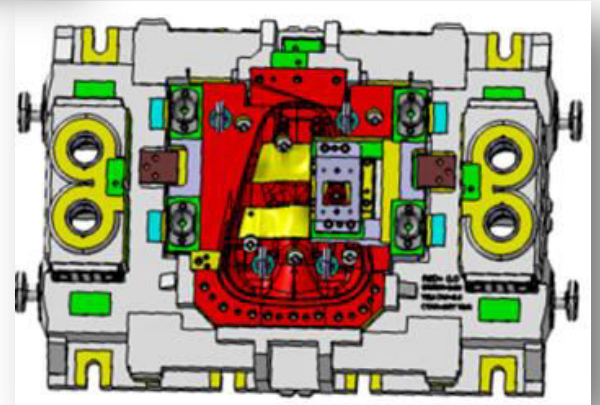
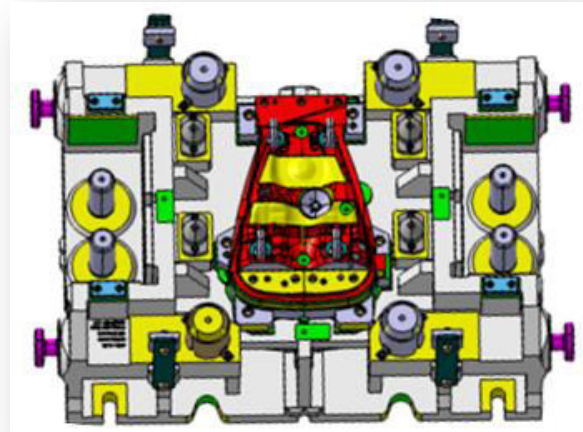
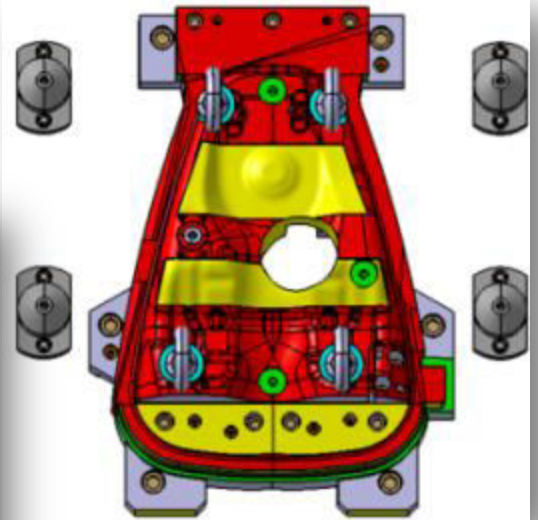
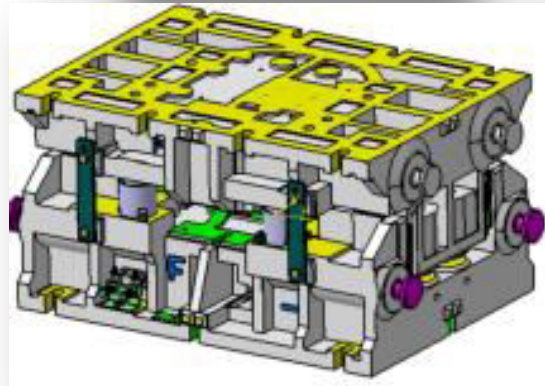
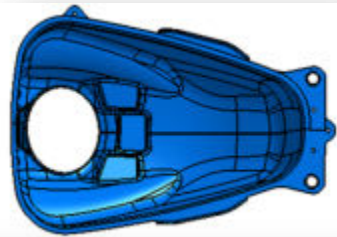
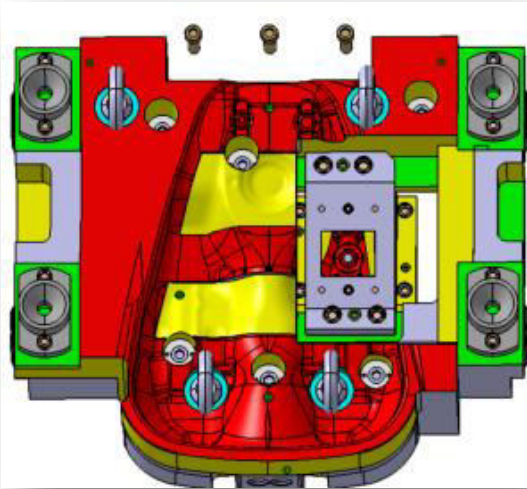

Thank You.....



Address :- Gat No. 255, Opp ' Modern' College,
Behind ' ROSS' Company, Moshi- Dehu Road,
Moshi Pune - 412 105.

Web Site :-www.richcamtooling.com