



G.S PARKHE AWARD CII AWARD



**UNIVERSAL
ORBITAL
SYSTEMS
PVT. LTD.**
ISO 9001 : 2015

The Complete Orbital Welding Solution

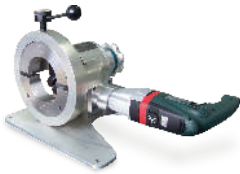
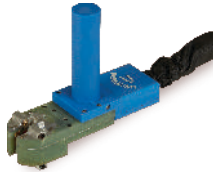
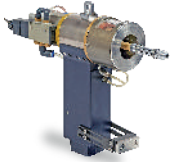

Orbital Welding Closed Arc Heads CA-25/ 75-M/ 100/ 150

Features

- ♦ Totally Enclosed Water Cooled Weld Heads
- ♦ Compact Design to Permit Use in Situations Where Access is Limited
- ♦ Shielded-Gas Chamber to Prevent OD Discoloration
- ♦ Quick Change Collets Systems
- ♦ Welding on Actual Position
- ♦ Simple & Rugged Design
- ♦ DC Motor with Encoder



Technical Specifications

Description	Unit	CA-25	CA-50	CA-75-M	CA-100	CA-150
Diameter of Work Piece	mm	6 to 25.4	8 to 50.8	12.7 to 76.2	25.4-101.6	38-152.4
Speed Range	Rot / min	0.4 to 4	0.3 - 3	0.2 5- 2.5	0.16-1.6	0.16-1.6
Power	Watts	25	25	25	25	25
Weight	Kg	3	4.5	5	6.5	9
Cable Length	Mtr	8	8	8	8	8

Dimensions

HEAD TYPE	A	B	C	D	E	F
CA-25	90	53	144	361	35	17.5
CA-50	130	72	180	420	48	24
CA-75-M	138	84	200	433	48	24
CA-100	200	105	280	517	50	25
CA-150	264	130	355	565	56	26.5

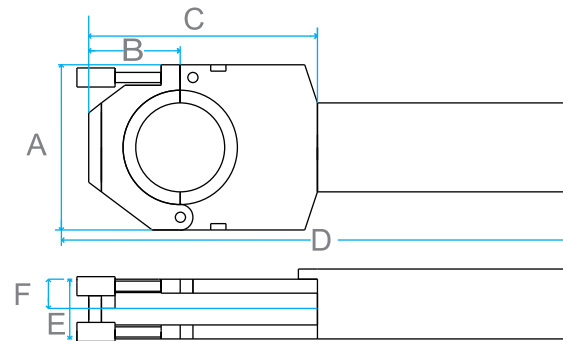

Accessories

Carrying case



TC Attachment



Purging Caps



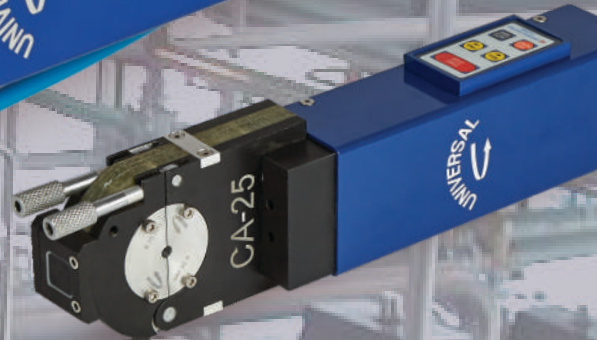
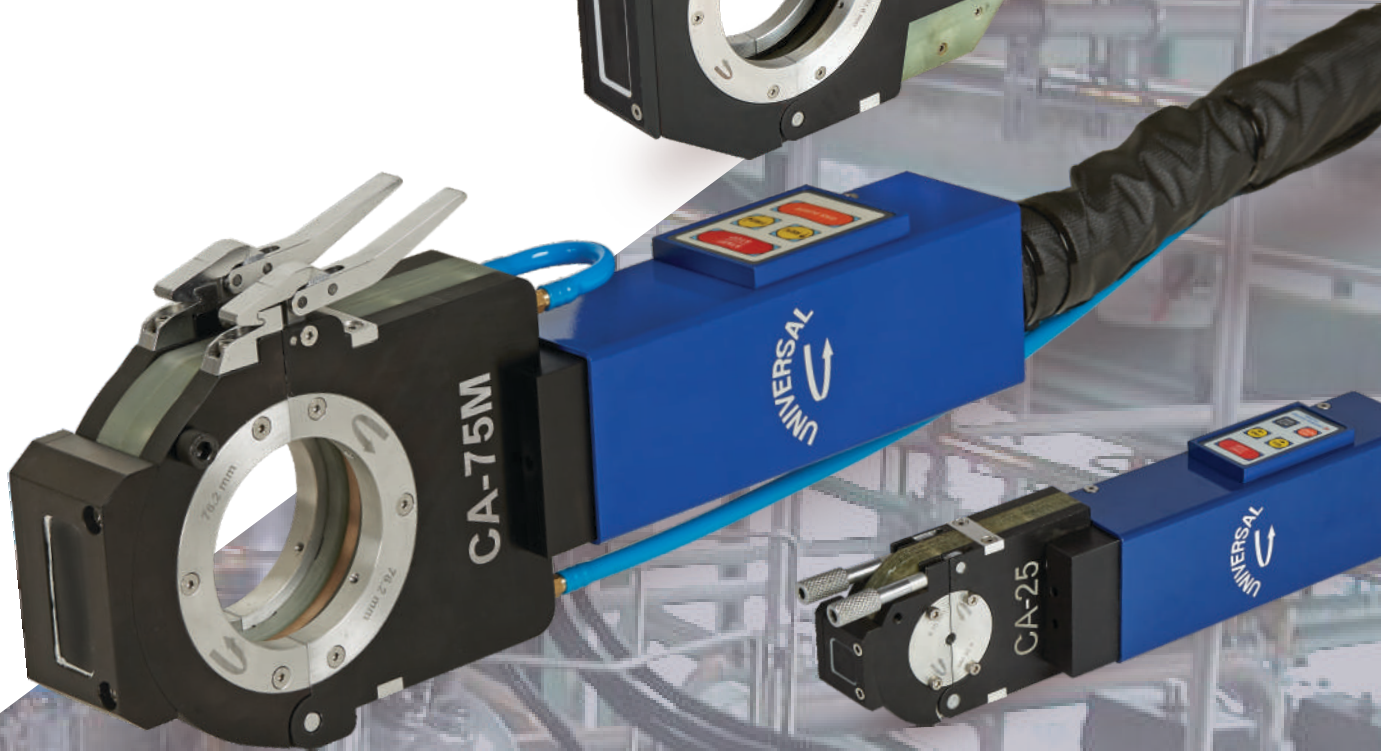
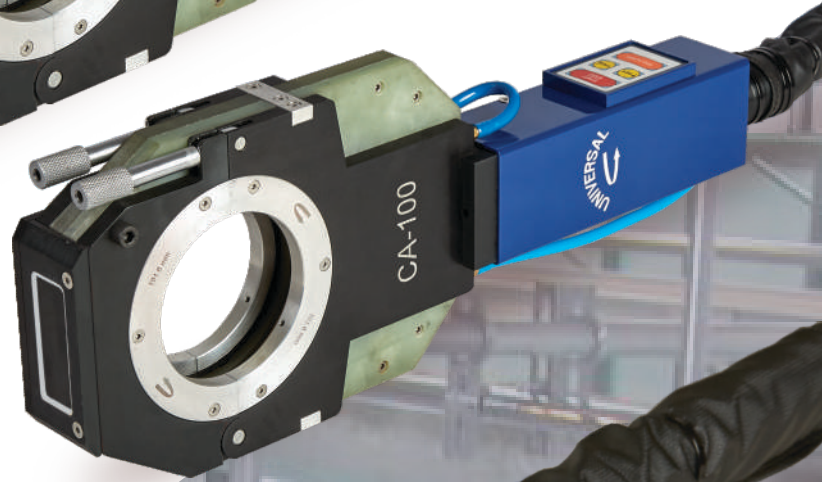

Compact Orbital Welding GTAW Power Source ORBITRON-6000/ 7000

Printout

PROJECT DONE BY		
PRAJ HIPURITY		
CLIENT NAME		
SIRUM PHARMA		
OPERATOR NAME omkar		
HEAD TYPE CA-75 (M)		
CONTROLLER TYPE ORBITRON-7000		
MACHINE SR. NO.: 160701		
DATE 22/07/2016 TIME 16:17:34		
WELD NO.: 140		
TUBE THICKNESS 1.6 TUBE DIA 38.1		
mm (mm)		
PREHEAT (S) 1.5		
POST FLOW (S) 30.0 PREFLOW (S) 30.0		
HIGH PULSE (S) 0.25 LOW PULSE (S) 0.25		
BASE CURRENT (A) 20		
LEVEL TRAVEL	SPEED	CURRENT
DEGREE	%	(A)
A 0	35	65.0
B 90	35	64.0
C 180	35	64.0
D 220	35	64.0
E 270	35	64.0
F 300	35	63.0
G 330	35	63.0
H 360	35	62.0
I 410	40	60.0
APPROVED BY:		

Features

- ◆ Auto programming mode generates welds procedures Automatically.
- ◆ Stores 600 programs 200 Auto and 400 Manuals programs.
- ◆ Manual programs can be stored with Tags.
- ◆ Compact, Rugged, Noise Proof Design, Weighing only 15 Kg, easy carrying for site and runs on generators also.
- ◆ A simple design, Easy to understanding for all Operators.
- ◆ Segment wise programming with Positional Reference.
- ◆ In built Weld Data Logger with USB Port & Pen Drive
- ◆ Auto fault detection detects “Arc Fault”, “Rotor Jam”, “Earth Fault” “Gas Fault” and user guidance to fix the fault.
- ◆ Suitable for all UNIVERSAL Weld Heads including Tube To Tube and Tube To Tube Sheet.
- ◆ Password protected key function for user levels such as Welder, Supervisor, Admin.
- ◆ Auto tacking facility.
- ◆ Specially tuned GTAW Power Source with highly stable current for Orbital Welding.
- ◆ Separate compact water cooling unit for Weld Head Cooling.
- ◆ IoT connected power source by which you can communicate the machine and get Daily Reports for Orbitron 7000.
- ◆ You can see machine status on Cloud, Android can monitor continuously from your PC/ Mobile for Orbitron 7000.

Water Cooling Unit (WT4)

Capacity	4 Ltrs.
Dimension (mm)	L (350) H (165) W (150)
Weight	4 Kg



Orbitron 6000

ORBITRON 7000 IoT Connected

A true smart digital power source for orbital weld heads with IoT Connected. A highly reliable, accurate, consistent, rugged, workhorse suitable for site conditions.



ORBITRON 6000/7000

Auto Programming

New auto program generates auto weld procedures
Need to enter tube O.D and thickness and weld head type

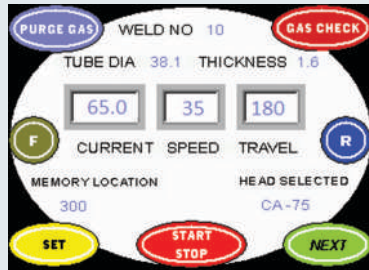

Startup Display

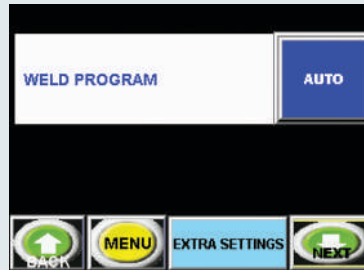

Auto Program Selection



Tube Size Selection

Specifications:

Application	For use with all UNIVERSAL weld head, Welding lathe, SPM.
Function controlled	Weld current/ pulse, Weld head rotation, Gas solenoid
Line Power	230VAC + -15% 50Hz Single Phase, 15 A , 4KVA
Motor Control	24VDC, 1A
Number of Weld Program can be stored	200 program in AUTO mode 400 program in MANUAL mode
Weld Data Logger Reading Storing capacity	3000
Data recording/ printout	Operator name, Weld ID number, O.D., Wall thickness Date, Time, Weld head model, Project, Drawing Number, Programmed Parameters
Dimensions	(L)510 (H)390 (W)220 / (L)510 (H)350 (W)240
Operating temperature	-18 c to 50 c
Output Current	10A TO 160 A
Pulse Rate	0.2 TO 100 Pulse /Sec
Open ARC Voltage	75 VDC
Weight	15 KG

Orbitron 7000 Iiit Connected

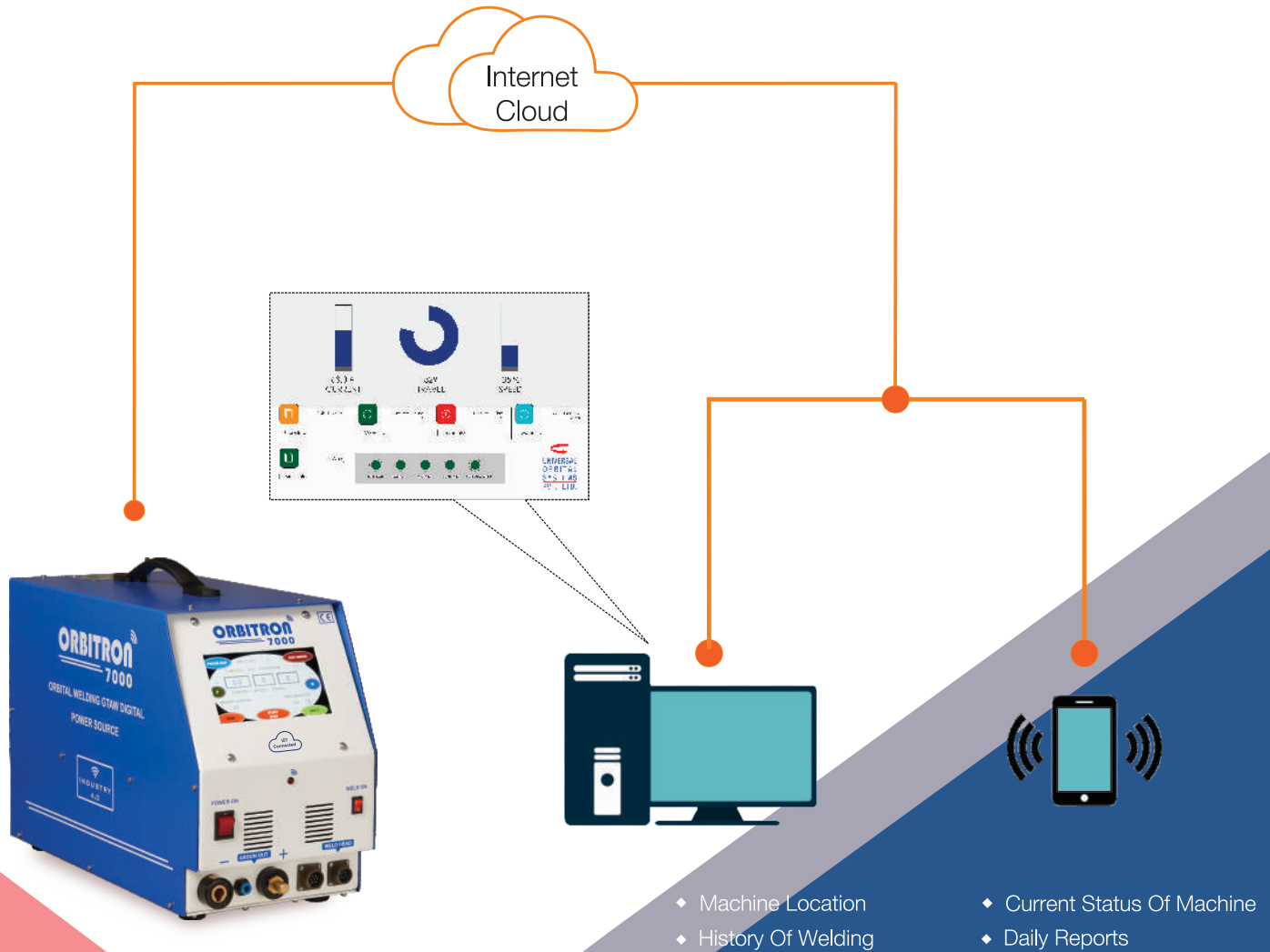

Orbital Pipe Cutter

R4 LITE

Features

- ◆ Reliable & cost effective solution to square cut for all types of metal pipe
- ◆ A precise, square and clean cut
- ◆ Unnecessary to do any additional preparation work on the cut-off face for orbital welding
- ◆ Light weight sturdy design

Technical Specifications

Pipe O.D.	3/4" - 4"
Wall Thickness (inch)	0.02" - 0.12"
Wall Thickness (mm)	0.5 - 3
Approximate Weight (kg)	25
Power Input	1000 W
Voltage / Frquency	220V / 50-60Hz



Tube Facing Machine TF-1.5 / TF-4

The portable tube squaring machine is specially designed to flatten and bevel tube end, making it burr-free, and perfect straight to the axis of the tube.

After facing, the tube would be ready for orbital welding or other tube fabrication, ideal for high purity / high sanitary industry use, such as Beverage, Dairy, Pharmaceuticals, Water treatment, Food, Semi-conductor industry etc.

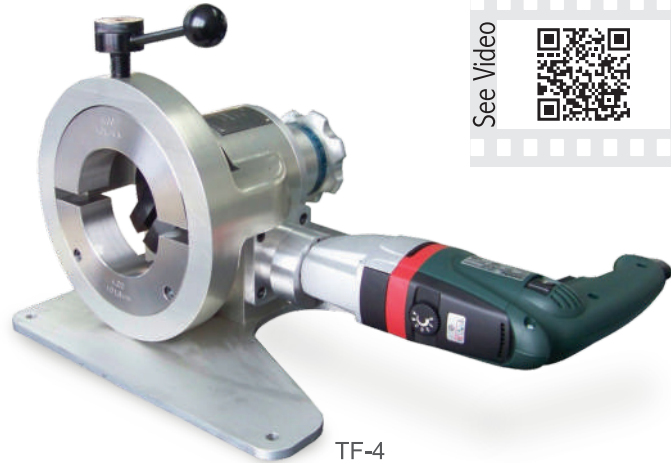

See Video



Features

- ◆ Faces and Bevel most metals including stainless steel, nickel and carbon steels, chrome, copper-nickel alloy, aluminum
- ◆ Wide range of collets (clamp)/ OD Mounting Saddles available, to avoid any tube distortion
- ◆ TF 4 Model Range : 1" OD to 4 "OD
- ◆ Can face and bevel tube wall thickness up to 8 mm
- ◆ 120/220 V powerful Metabo electrical motor
- ◆ Micro feed system
- ◆ Supply full range of bevel and squaring Bit



Technical Specifications

	TF-1.5	TF-4
Pipe O.D.	0.25" - 1.5"	1" - 4"
Wall Thickness (inch)	0.019" - 0.078"	0.04" - 0.15"
Wall Thickness (mm)	0.5 - 2	1 - 4
Approximate Weight (kg)	7.5	19
Power Input	1000 W	1000 W
Voltage / Frquency	220V / 50-60Hz	220V / 50-60Hz

Tungsten Grinder

The Tungsten grinder TS-PPE is an excellent tool for hand orbital welding when using tungsten electrodes.

The grind is always consistent for precise arc striking and concentration.

The standard unit has a fixed angle 20 degrees included.

The diamond wheel is double sided and the movable disk allows the settings for two grooves on the top; as well as, two on the bottom so the entire wheel is used for grinding.

See Video



Features

- ◆ Double Sided Diamond Wheel
- ◆ 230 Volt AC Motor with Variable Speed
- ◆ Collets for 1.6, 2, 2.4, 3.2 mm Tungsten
- ◆ Double Insulated Motor
- ◆ Stainless Steel Collets



Video Borescope

Features

- ◆ Diameters : 5.8, 8, 10 mm
- ◆ Lengths : 2 to 10 Meter Length Available
- ◆ Without Articulation / With Articulation : 4-Way
- ◆ High Resolution CCD Image
- ◆ High Definition VGA LCD Display
- ◆ Built-in Video Recording & Digital Image Capture

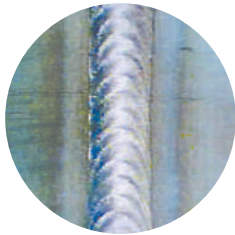



**UNIVERSAL
ORBITAL
SYSTEMS
PVT. LTD.**

30/5A, 3, Samruddhi Industrial Estate,
Narhe Dhayari Road,
Dhayari, Pune-411041
Phone : +91-20-65 28 98 70/71
M : +91 90 11 14 04 71
Email : sales@universalorbital.com
www.universalorbital.com

